

# INSTRUCTION & SERVICE MANUAL

## A121 AlertAlarm Sounder

- -40°C to +66°C (104°F to 151°F)
- Type 4 / 4X / 3R / 13, IP66
- 2.1Kg (4.62lb)
- CE, A121XDC024 & A121XDC048 CPR compliant, All units UL Listed

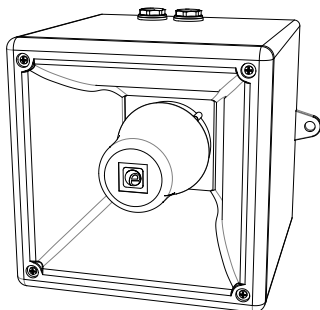

Unit Type Code	Nominal Voltage	Voltage Range	Nominal Current* P2	Nominal Current* P3	Nominal SPL P2 / P3	Max SPL P2 / P3	Average SPL P2 / P3
A121DC024	12 Vdc	11.5-54Vdc	376mA	440mA	116.9dB(A) / 120.2dB(A) Tone 44 @ 1m	120.7dB(A) / 123.4dB(A) Tone 4 @ 1m	115.3dB(A) / 118.1dB(A) All Tones @ 1m
	24 Vdc		430mA	930mA			
	48 Vdc		223mA	453mA			
A121AC230	115 Vac	100-240Vac 50/60Hz	173mA	340mA			
	230 Vac		105mA	212mA			

\*Nominal current at nominal voltage

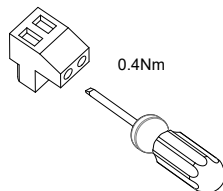
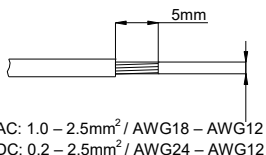

Attention: Installation must be carried out by an electrician in compliance with the latest codes and regulations.

Attention: L'installation doit être effectuée par un électricien conformément aux derniers codes et réglementations.

Achtung: Die Installation muss von einem Elektriker gemäß den neuesten Vorschriften und Bestimmungen durchgeführt werden.

Attenzione: L'installazione deve essere eseguita da un elettricista in conformità con i codici e le normative più recenti.

Atención: La instalación debe ser realizada por un electricista de acuerdo con los últimos códigos y regulaciones.

Atenção: A instalação deve ser realizada por um electricista de acordo com os códigos e regulamentos mais recentes.

Внимание: установка должна выполняться электриком в соответствии с последними нормами и правилами.

Attention: Disconnect from power source before installation or service to prevent electric shock

Attention: Débranchez-le de la source d'alimentation avant l'installation ou l'entretien pour éviter tout choc électrique.

Achtung: Vor Installation oder Wartung von der Stromquelle trennen, um einen Stromschlag zu vermeiden.

Attenzione: scollegare dall'alimentazione prima dell'installazione o dell'assistenza per evitare scosse elettriche.

Atención: desconéctelo de la fuente de alimentación antes de la instalación o el servicio para evitar descargas eléctricas.

Atenção: Desconecte da fonte de alimentação antes da instalação ou serviço para evitar choque elétrico

Внимание: отключите от источника питания перед установкой или обслуживанием, чтобы предотвратить поражение электрическим током.



DC

See D221-06-001

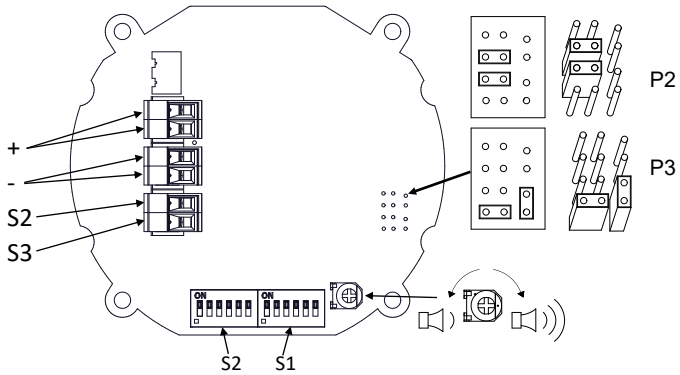

AC

See D221-06-005

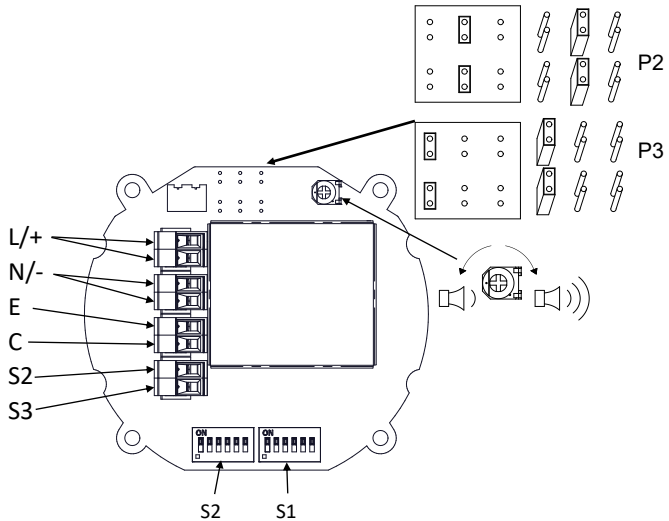

(DC Only, see D221-06-001)

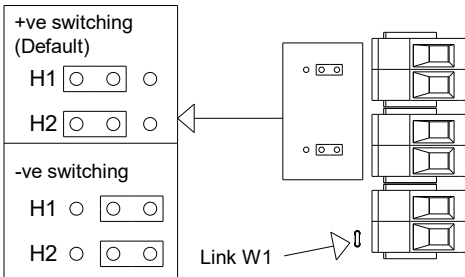

(AC & DC, See D221-95-001)

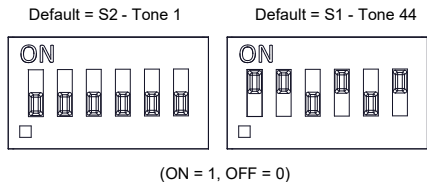

INSTRUCTION & SERVICE MANUAL  
A121 AlertAlarm Sounder

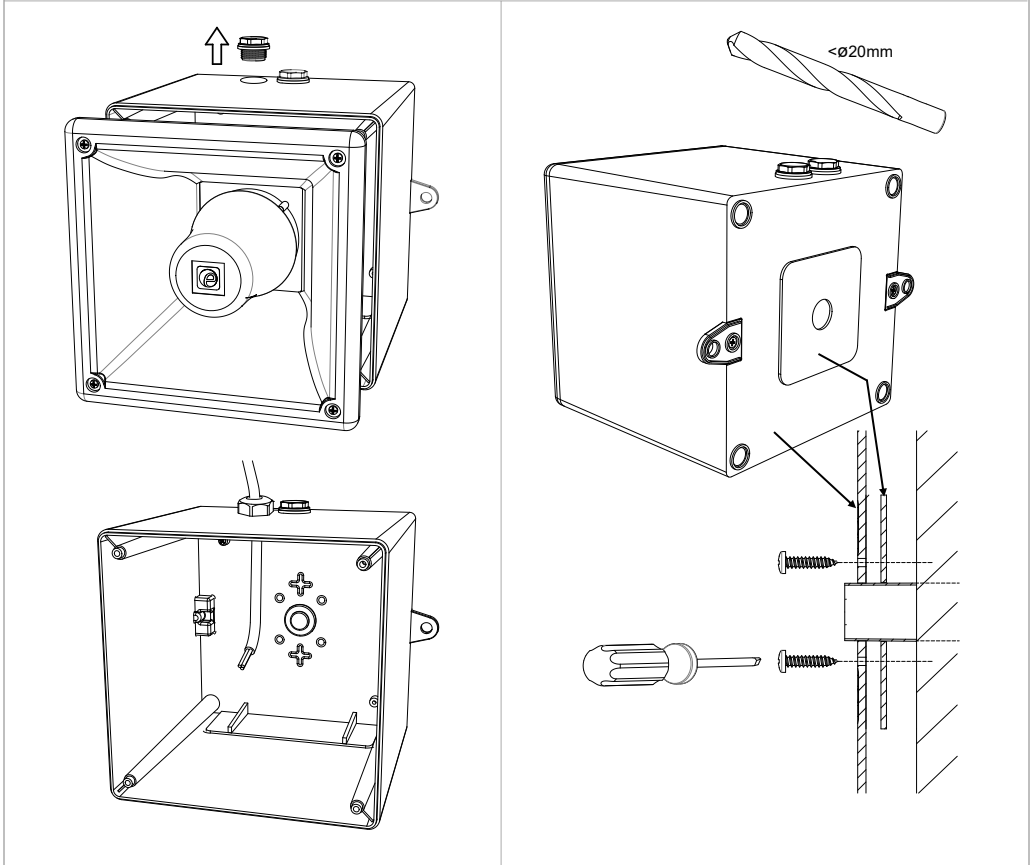
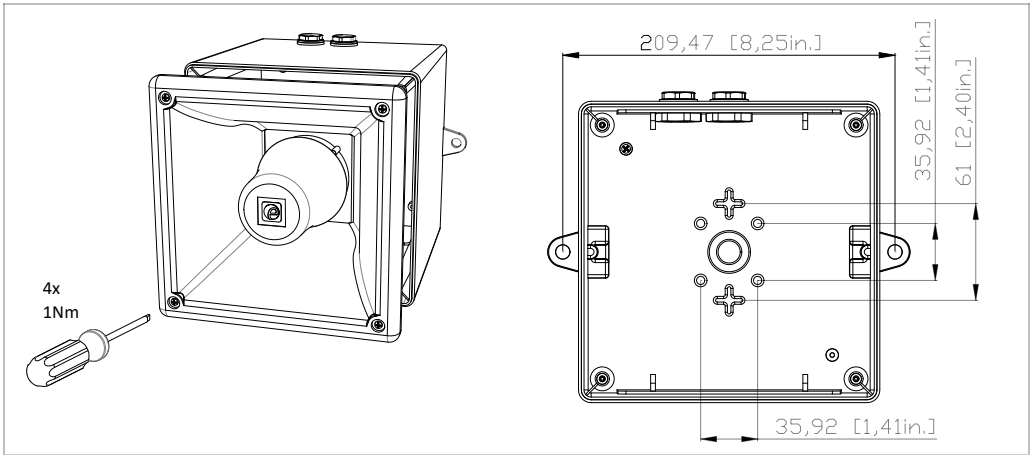

### Construction Product Regulation

- A121DC024 is compliant to EN54-3:2001+A1+A2
- Alarm devices – Sounder for use in fire detection and fire alarm systems installed in and around buildings
- Type 4 / 4X / 3R / 13, IP66, Independently tested to EN60529:1991, (IP33C Compliant to EN54-3)
- Type B Product, For Indoor & Outdoor use
- Observe Precautions for handling electrostatic devices
- -25°C to +55°C compliant to EN54-3
- Cable Glands must be suitably sealed and meet minimum IP33 for EN54-3 applications
- Storage Temperature: -40°C to +70°C
- Maintenance – None
- Mounting - Units can be mounted using the 2-off ø9mm holes in the mounting lugs or through the back of the housing using the supplied gasket seal.

Order Code: A121DC024  
 Voltage Range: 16-54Vdc  
 Nominal Voltage: 24Vdc  
 Max Current: 930mA @ 24Vdc  
 DP-2821-CPR-0108



### Approved Tones for EN54-3 Applications:

- (Alternating Tone) 800/1000Hz @ 2Hz Alternating Tone 44
- (Rising Tone) 500/1200Hz @ 0.26Hz (3.3s on, 0.5s off) Tone 8
- (Fainting Tone) 1200/500Hz @ 1Hz Tone 2
- (Continuous Tone) 800Hz Tone 21
- (Pulsed Tone) 660Hz (150mS on, 150mS off) Tone 31
- (Alternating Tone) 544Hz(100mS)/440Hz (400mS) Tone 5

A121DC024 (P2) @ 1m

Angle	Horizontal Sound Output Max Voltage (54 Vdc) LAFmax,T dB(A)						Horizontal Sound Output Min Voltage (11.5 Vdc) LAFmax,T dB(A)					
	Tone 44	Tone 8	Tone 2	Tone 21	Tone 31	Tone 5	Tone 44	Tone 8	Tone 2	Tone 21	Tone 31	Tone 5
15°	106.1	105.8	105.1	105.4	105.2	93.9	101.2	101.6	101.1	101	101.2	91
45°	105.2	107.2	106.3	104.1	98.7	101.6	101.3	102.9	102.1	100.2	94.7	99
75°	112.1	112.6	111.9	111.7	110.1	104.8	108.1	108.5	107.7	108.1	106.5	103
105°	111.9	112.5	111.7	111.7	110.2	104.8	107.9	108.4	107.6	108.1	106.4	103
135°	104.8	107.4	106.4	103.8	99.2	101.6	101.1	103.2	102.1	99.8	95.5	99
165°	105.2	105.8	105.2	105.3	105.1	93.8	100.8	101.5	100.8	100.9	102	90.8

Angle	Vertical Sound Output Max Voltage (54 Vdc) LAFmax,T dB(A)						Vertical Sound Output Min Voltage (11.5 Vdc) LAFmax,T dB(A)					
	Tone 44	Tone 8	Tone 2	Tone 21	Tone 31	Tone 5	Tone 44	Tone 8	Tone 2	Tone 21	Tone 31	Tone 5
15°	107.2	107.1	105.9	107.4	105.5	95.5	103.1	102.8	101.5	103.1	101.5	91.8
45°	106	109.3	107.9	104.6	100.5	103.7	102.2	105.4	103.8	100.4	96.6	99.9
75°	113.2	113.3	112.9	113	110.8	106.1	109.2	109.3	108.7	109.1	107.1	103
105°	112.9	113.1	112.7	112.8	111.4	106.1	109	108.9	108.5	108.9	107.7	103.1
135°	105.5	109.3	107.7	104.7	100.3	104.3	101.4	105.3	103.5	100.7	96.5	100.7
165°	107	106.5	105.9	106.4	105.3	95	102.6	102.1	101.5	102.2	101.1	91.2

A121DC024 (P3) @ 1m

Angle	Horizontal Sound Output Max Voltage (54 Vdc) LAFmax,T dB(A)						Horizontal Sound Output Min Voltage (11.5 Vdc) LAFmax,T dB(A)					
	Tone 44	Tone 8	Tone 2	Tone 21	Tone 31	Tone 5	Tone 44	Tone 8	Tone 2	Tone 21	Tone 31	Tone 5
15°	107.5	108.4	107.1	106.8	106.5	105.1	104.2	105.3	104.6	103.5	104.7	102.6
45°	112.8	114.8	113.7	111.9	102.5	104.5	109.7	111.2	110.7	108.9	100.4	101.7
75°	115.2	116.7	115.4	115.5	112.5	113	112.2	113.2	112.7	112.5	110.1	110.3
105°	115.6	116.5	115.7	116	113.7	113	112.6	113.4	113.1	112.9	111.1	110.1
135°	112.8	114.7	113.7	111.7	102.3	104.6	109.7	111.2	110.7	108.9	100.1	101.7
165°	107.5	108.4	106.9	107	106.5	104.9	104.3	104.9	104.2	103.5	104.5	102.3

Angle	Vertical Sound Output Max Voltage (54 Vdc) LAFmax,T dB(A)						Vertical Sound Output Min Voltage (11.5 Vdc) LAFmax,T dB(A)					
	Tone 44	Tone 8	Tone 2	Tone 21	Tone 31	Tone 5	Tone 44	Tone 8	Tone 2	Tone 21	Tone 31	Tone 5
15°	107.4	108.2	107.3	105.9	106.3	105.3	104.2	105.3	104.7	103.3	104.6	102.7
45°	112.7	114.7	113.5	111.8	102.4	104.6	109.8	111.2	110.8	109	100.3	101.7
75°	115.3	116.4	115.6	115.4	113.3	112.5	112.4	112.8	112.8	112.5	110.7	110.1
105°	115.3	116.4	115.6	115.6	113.5	113	112.3	112.9	113	112.7	111	110
135°	112.6	114.7	113.5	112.3	102.5	104.8	109.7	111.3	110.9	109.2	100.3	101.9
165°	107.6	108.1	106.9	105.8	106.3	104.9	104.4	105.1	104.4	103.3	104.4	102.3

# INSTRUCTION & SERVICE MANUAL

## A121 AlertAlarm Sounder

- All models are approved for use as Audible Signal Appliance for use as General Signaling: UL464A & CSA C22.2 No 205-17
- Type 4 / 4X / 3R / 13, IP66
- 40°C to +66°C / -40°C to +151°F  
General Signaling Canada:  
A121DC024: -40°C to +55°C / -40°F to +131°F  
A121AC230: -40°C to +40°C / -40°F to +104°F



- To maintain Ingress Protection, cable entries must be fitted with suitably rated cable glands or stopping plugs
- EOL Monitoring (DC Only): End of Line Devices may be fitted between the +ve & -ve terminals of the PCBA. Please ensure that the device legs meet the wire size range stated for the connection terminals and are fitted correctly in order to avoid a short. Refer to the compatible control panel specification for EOL device values and ratings.

Model	Nominal Voltage	Voltage Range	P2 Nominal Operating Current <sup>#</sup>	P3 Nominal Operating Current <sup>#</sup>	P2 Max Operating RMS <sup>*</sup>	P3 Max Operating RMS <sup>*</sup>
A121DC024	12V dc	11.5 - 54V ac	376mA	440mA	430mA	930mA
	24V dc		430mA	930mA		
	48V dc		223mA	453mA		
A121AC230	115V ac	100- 240V ac 50/60Hz	173mA	340mA	181mA	383mA
	230V ac		105mA	212mA		

\*Max Operating current for worst-case input voltage; Nominal current at nominal voltage and Tone 12

The units have been tested and approved to DNVGL-CG-0339 & EN54-3:2014 incl. A1:2019 for the installation on ships in the following locations:

Temperature: A, B, C & D (Machinery spaces, control rooms, accommodation, bridge, inside cubicles, desks, etc..., pump rooms, holds, rooms with no heating, Open deck, masts)

Humidity: A & B (All locations)

Vibration: A (Bulkheads, Beams, Deck, Bridge)

EMC: A & B (All locations Including Bridge & open deck)

Enclosure: A, B & C (Control rooms, accommodation, bridge, engine room, open deck masts, below floor plates in engine room)





The units comply with Solas 74 Chapter II-2, Regulation 7 & Chapter X, Regulation 3 for installation on ships in the following locations:

Temperature: D (Location -25° to +70°C)

Vibration: A (General Applications)

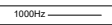
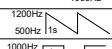
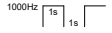
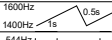
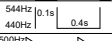
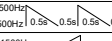
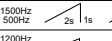
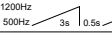
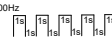
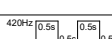
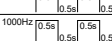
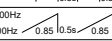
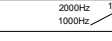
EMC: B (Bridge & Open Deck Zone)

Enclosure: IP56, Salt mist

Stage 1 Set DIP SW 1 Tone No.	Tone Description	Tone Visual	Stage 1 & 2 DIP SW 1/2 Settings 1 2 3 4 5 6	Stage 3 Set DIP SW 1 (S3)	Stage 4 Set DIP SW 1 (S2 + S3)
1	1000Hz PFEER Toxic Gas		0 0 0 0 0 0	2	44
2	1200/500Hz @ 1Hz DIN /PFEER P.T.A.P.		1 0 0 0 0 0	3	44
3	1000Hz @ 0.5Hz(1s on, 1s off) PFEER Gen. Alarm		0 1 0 0 0 0	2	44
4	1.4KHz-1.6KHz 1s, 1.6KHz-1.4KHz 0.5s NF C 48-265		1 1 0 0 0 0	24	1
5	544Hz(100mS)/440Hz (400mS) NF S 32-001		0 0 1 0 0 0	19	1
6	1500/500Hz - (0.5s on, 0.5s off) x3 + 1s gap AS4428		1 0 1 0 0 0	44	1
7	500-1500Hz Sweeping 2 sec on 1 sec off AS4428		0 1 1 0 0 0	44	1
8	500/1200Hz @ 0.26Hz (3.3son, 0.5s off) Netherlands - NEN 2575		1 1 1 0 0 0	24	35
9	1000Hz (1s on, 1s off)x7 + (7s on, 1s off) IMO Code 1a		0 0 0 1 0 0	34	1
10	1000Hz (1s on, 1s off)x7 + (7s on, 1s off) IMO Code 1a		1 0 0 1 0 0	34	1
11	420Hz(0.5s on, 0.5s off)x3 + 1s gap ISO 8201 Temporal Pattern		0 1 0 1 0 0	1	8
12	1000Hz(0.5s on, 0.5s off)x3 + 1s gap ISO 8201 Temporal Pattern		1 1 0 1 0 0	1	8
13	422/775Hz - (0.85 on, 0.5 off) x3 + 1s gap NFPA - Temporal Coded		0 0 1 1 0 0	1	8
14	1000/2000Hz @ 1Hz Singapore		1 0 1 1 0 0	3	35
15	300Hz Continuous (f=300)		0 1 1 1 0 0	24	1
16	440Hz Continuous (f=440)		1 1 1 1 0 0	24	1
17	470Hz Continuous (f=470)		0 0 0 0 1 0	24	8
18	500Hz Continuous IMO code 2 (Low) (f=500)		1 0 0 0 1 0	24	8
19	554Hz Continuous (f=554)		0 1 0 0 1 0	24	8
20	660Hz Continuous (f=660)		1 1 0 0 1 0	24	35
21	800Hz IMO code 2 (High) (f=800)		0 1 0 1 0 0	24	35
22	1200Hz Continuous (f=1200)		1 0 1 0 1 0	24	35
23	2000Hz Continuous (f=2000)		0 1 1 0 1 0	3	35
24	2400Hz Continuous (f=2400)		1 1 1 0 1 0	20	35
25	440Hz @0.83Hz (50 cycles/minute) Intermittent (f=440, a=0.6, b=0.6)		0 0 0 1 1 0	44	8
26	470Hz @0.9Hz - 1.1s Intermittent (f=470, a=0.55, b=0.55)		1 0 0 1 1 0	44	8
27	470Hz @5Hz - (5 cycles/second) Intermittent (f=470, a=0.1, b=0.1)		0 1 0 1 1 0	44	8
28	544Hz @ 1.14Hz - 0.875s Intermittent (f=470, a=0.43, b=0.44)		1 1 0 1 1 0	24	8
29	655Hz @ 0.875Hz Intermittent (f=655, a=0.57, b=0.57)		0 0 1 1 1 0	24	8
30	660Hz @0.28Hz - 1.8sec on, 1.8sec off Intermittent (f=660, a=1.8, b=1.8)		1 0 1 1 1 0	24	8
31	660Hz @3.34Hz - 150mS on, 150mS off Intermittent (f=660, a=0.15, b=0.15)		0 1 1 1 1 0	24	8
32	745Hz @ 1Hz Intermittent (f=745, a=0.5, b=0.5)		1 1 1 1 1 0	24	8
33	800Hz - 0.25sec on, 1 sec off Intermittent (f=800, a=0.25, b=1)		0 0 0 0 0 1	24	8
34	800Hz @ 2Hz IMO code 3.a (High) Intermittent (f=800, a=0.25, b=0.25)		1 0 0 0 0 1	24	19
35	1000Hz @ 1Hz Intermittent (f=1000, a=0.5, b=0.5)		0 1 0 0 0 1	24	19
36	2400Hz @ 1Hz Intermittent (f=2400, a=0.5, b=0.5)		1 1 0 0 0 1	24	19
37	2900Hz @ 5Hz Intermittent (f=2900, a=0.1, b=0.1)		0 0 1 0 0 1	24	19
38	363/518Hz @ 1Hz Alternating (f=363, f1=518, a=0.1)		1 0 1 0 0 1	8	19
39	450/500Hz @ 2Hz Alternating (f=450, f1=500, a=0.25)		0 1 1 0 0 1	8	19
40	554/440Hz @ 1Hz Alternating (f=440, f1=554, a=0.5)		1 1 1 0 0 1	24	19
41	554/440Hz @ 0.625Hz Alternating (f=440, f1=554, a=0.8)		0 0 0 1 0 1	8	19
42	561/760Hz @0.83Hz (50 cycles/minute) Alternating (f=561, f1=760, a=0.6)		1 0 0 1 0 1	8	19
43	780/600Hz @ 0.96Hz Alternating (f=600, f1=780, a=0.52)		0 1 0 1 0 1	8	19
44	800/1000Hz @ 2Hz Alternating (f=800, f1=1000, a=0.25)		1 1 0 1 0 1	24	19
45	970/800Hz @ 2Hz Alternating (f=800, f1=970, a=0.25)		0 0 1 1 0 1	8	19
46	800/1000Hz @ 0.875Hz Alternating (f=800, f1=1000, a=0.57)		1 0 1 1 0 1	24	19
47	2400/2900Hz @ 2Hz Alternating (f=2400, f1=2900, a=0.25)		0 1 1 1 0 1	24	19
48	500/1200Hz @ 0.3Hz Sweeping (f=500, f1=1200, a=3.34)		1 1 1 1 0 1	24	12
49	560/1055Hz @ 0.18Hz Sweeping (f=560, f1=1055, a=5.47)		0 0 0 0 1 1	24	12
50	560/1055Hz @ 3.3Hz Sweeping (f=560, f1=1055, a=0.3)		1 0 0 0 1 1	24	12
51	600/1250Hz @ 0.125Hz Sweeping (f=600, f1=1250, a=8)		0 1 0 0 1 1	24	12
52	660/1200Hz @ 1Hz Sweeping (f=660, f1=1200, a=1)		1 1 0 0 1 1	24	12
53	800/1000Hz @ 1Hz Sweeping (f=800, f1=1000, a=1)		0 1 0 0 1 1	24	12
54	800/1000Hz @ 7Hz Sweeping (f=800, f1=1000, a=0.14)		1 0 1 0 1 1	24	12
55	800/1000Hz @ 50Hz Sweeping (f=800, f1=1000, a=0.02)		0 1 0 1 0 1	24	12
56	2400/2900Hz @ 7Hz Sweeping (f=2400, f1=2900, a=0.14)		1 1 1 0 1 1	24	12
57	2400/2900Hz @ 1Hz Sweeping (f=2400, f1=2900, a=1)		0 0 0 1 1 1	24	12
58	2400/2900Hz @ 50Hz Sweeping (f=2400, f1=2900, a=0.02)		1 0 0 1 1 1	24	12
59	2500/3000Hz @ 2Hz Sweeping (f=2500, f1=3000, a=0.5)		0 1 0 1 1 1	24	12
60	2500/3000Hz @ 7.7Hz Sweeping (f=2500, f1=3000, a=0.13)		1 1 0 1 1 1	24	12
61	800Hz Motor Siren (f=800, a=1.6)		0 0 1 1 1 1	24	12
62	1200Hz Motor Siren (f=1200, a=2)		1 0 1 1 1 1	24	12
63	2400Hz Motor Siren (f=2400, a=1.7)		0 1 1 1 1 1	24	12
64	Simulated Bell		1 1 1 1 1 1	21	12

**FIRE INSTRUCTION & SERVICE MANUAL**  
**A121 Range AlertAlarm Sounder UL464 / CAN/ULC-S525**  
**Model: A121DC**



Attention: Installation must be carried out by an electrician in compliance with the National Electrical Code, NFPA 70, and the National Fire Alarm Signaling Code, NFPA 72 or CSA 22.1 Canadian Electrical Code, Part I, Safety Standard for Electrical Installations, Section 32. / L'installation doit exclusivement être réalisée par du personnel qualifié, conformément au code national d'électricité américain, NFPA 70, et le code national d'alarme incendie et de signalisation NFPA 72 ou CSA 22.1 Code canadien de l'électricité, première partie, norme de sécurité relative aux installations électriques, Section 32



Attention: Disconnect from power source before installation or service to prevent electric shock / Débranchez-le de la source d'alimentation avant l'installation ou l'entretien pour éviter tout choc électrique.



Attention: Do not paint / Ne pas Peinturer

- 40°C to +66°C / -40°F to +151°F
- Units can be mounted using the 2-Off Ø9mm holes in the mounting lugs or through the back of the housing using the supplied gasket seal.
- A121DC024 is approved for use as an audible signal appliance for fire alarm use – Public Mode (UL464 & CAN/ULC-S525) and produces a minimum sound pressure level of P2: US: 93.67dB(A); CA: 101.2dB(A) / P3: US: 94.33dB(A); CA: 102.4dB(A) at 10 feet, (figures @ worst case 11.5Vdc).
- The A121DC024 produces a minimum sound pressure level of P2: US: 97.59dB(A) ; CA: 105.4dB(A) / P3: US: 100.63dB(A); CA: 107.5dB(A) at 10 feet (@24Vdc)
- For Fire Alarm applications, the Sounder Volume must be at the highest setting, (see volume control section). For fire alarm use, Tone 12 as shown below must be selected:

Stage 1 Set DIP SW 1 Tone No.	Tone Description	Tone Visual	Stage 1 & 2 DIP SW 1/2 Settings 1 2 3 4 5 6	Stage 3 Set DIP SW 1 (S3)	Stage 4 Set DIP SW 1 (S2 + S3)
12	1000Hz(0.5s on, 0.5s off)x3 + 1s gap ISO 8201 Temporal Pattern		1 1 0 1 0 0	1	8

- Connection Terminals: Pluggable  
 AC: 1.0 - 2.5mm<sup>2</sup> / AWG18 - AWG12  
 DC: 0.2 - 2.5mm<sup>2</sup> / AWG24 - AWG12
- Terminal Tightening torque 0.4Nm
- To maintain Ingress Protection, cable entries must be fitted with suitably rated cable glands or stopping plugs
- Units can be located indoor or outdoor wet use, wall or ceiling mounted and there are no limitations on orientation
- Factory finishes are not intended to be modified

**Surge Current Ratings for use in fire alarm systems**

Model	Nominal Voltage	Voltage Range	Initial Peak	Initial RMS
A121DC024	24V dc	11.5 - 54V dc	P2: 1164mA / P3: 1829mA	P2: 286mA / P3: 554mA

**A121DC024 Sounder Directional Characteristics for Canadian Fire CAN/ULC-S525 at 10 feet**

Horizontal Axis				Vertical Axis			
Angle	OSPL	Angle	OSPL	Angle	OSPL	Angle	OSPL
Ref. 90°	107.8 dB(A)	Ref. 90°	107.8 dB(A)	Ref. 90°	107.6 dB(A)	Ref. 90°	107.6 dB(A)
143°	-3 dB(A)	35°	-3 dB(A)	144.5°	-3 dB(A)	36.5°	-3 dB(A)
152°	-6 dB(A)	25°	-6 dB(A)	151°	-6 dB(A)	27°	-6 dB(A)
180°	97.8 dB(A)	0°	95.8 dB(A)	180°	96.8 dB(A)	0°	95.9 dB(A)

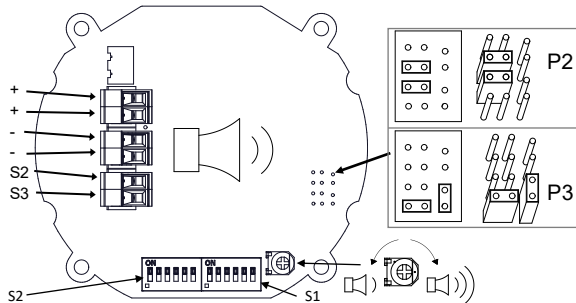

ISSUE		MOD No.	REASON - INITIAL - DATE
A		INTRODUCTION	
		RSR - 11/03/2021	

OPTIONAL LINE MONITORING RESISTOR, CUSTOMER SUPPLIED.  
 RECOMMENDED MINIMUM VALUES:  
 250V MAX SYSTEM = 470Ω MIN, 25V MIN OR 2.4KΩ MIN, 0.5W MIN

A	Single Stage Configuration	Config.: 1a	Two Stage Configuration	Config.: 1b	Three/Four Stage Configuration	Config.: 1c
	Line Monitoring Set to positive switching (default)	Common Negative	Set to positive switching (default)	Common Negative	Set to positive switching (default)	Common Negative
B	Stage 1: Apply Power to Stage 1 +ve & Stage 1 -ve	Stage 1: Apply Power to Stage 1 +ve & Stage 1 -ve	Stage 2: Apply Power to Stage 2 +ve & Common -ve	Stage 1: Apply Power to Stage 1 +ve & Common -ve Stage 2: Apply Power to Stage 2 +ve & Common -ve	Stage 1: Apply Power to Stage 1 +ve & Common -ve Stage 2: Apply Power to Stage 3 +ve & Common -ve Stage 3: Apply Power to Stage 3 +ve & Common -ve Stage 4: Apply Power to Stage 2 +ve, Stage 3 +ve & Common -ve	

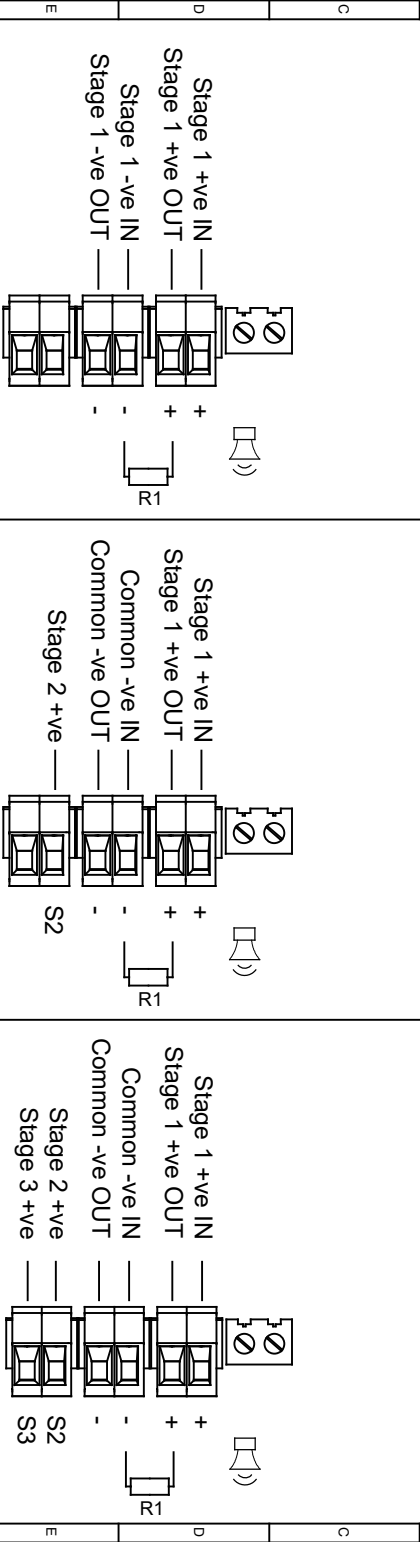



F	DRAWN	DATE	SURFACE FINISH	WEIGHT (KG)	THIS DRAWING AND ANY INFORMATION OR DESCRIPTION MATTER HEREIN IS UNMUTATED, UNCORRECTED AND UNREVISED. THE USER OF THIS DRAWING OR ANY INFORMATION SYSTEMS TO WHICH IT IS REFERRED OR ANY EXTRINSIC MANUFACTURING OR TENDERING PURPOSES WITHOUT THEIR WRITTEN CONSENT.	 AIRBUS/AVIATION/AS9100 REGISTERED DATE OF ISSUE SHOWN ABOVE	 European Safety Systems Ltd MANSFIELD ROAD LONDON WC1H WWW.ESS.CO.UK	ALL DIMENSIONS IN MM IF IN QUOTE 'ASK' DO NOT SCALE		A3
---	-------	------	----------------	-------------	--	--	---	---	--	----

G	DRAWING TO BE ENHANCED TO ISO 10111:1983 GEOMETRIC TOLERANCES TO ISO 10111:1983 ANGLE DIMENSIONAL TOLS	R.S. RAIT	16/03/2021							
S	STANDARDS	CHECKED B.ISARD	DATE 16/03/2021							
G	ALERT/ALARM RANGE	APPROVED R.N.POTTS	DATE 16/03/2021							

G	TITLE A112N & A121 DC SOUNDER WIRING DIAGRAMS	SCALE NTS	SHEET 1 OF 3	DRAWING NUMBER D221-06-001
---	--	--------------	-----------------	-------------------------------



OPTIONAL LINE MONITORING RESISTOR, CUSTOMER SUPPLIED.  
 RZ  
 14V MAX SYSTEM = 1200 MIN, 20V MIN OR HQ MIN, 0.5W MIN  
 28V MAX SYSTEM = 4700 MIN, 20V MIN OR 2.4KQ MIN, 0.5W MIN

 SWITCHES FOR STAGE OPERATION  
 CUSTOMER SUPPLIED

**Three/Four Stages, Voltage Free 2nd, 3rd & 4th Stage Activation Configuration** Config.: 2

Common Positive

- Customer Set H1 & H2 to Negative Switching (See Below)
- Stage 1: Apply Power to Common +ve & Stage 1 -ve
- Stage 2: Apply Power to Common +ve & Stage 1 -ve & connect Stage 2 -ve to Stage 1 -ve
- Stage 3: Apply Power to Common +ve & Stage 1 -ve & connect Stage 3 -ve to Stage 1 -ve
- Stage 4: Apply Power to Common +ve & Stage 1 -ve & connect Stage 2 -ve & Stage 3 -ve to Stage 1 -ve

**Two Stage Configuration** Config.: 3

Independent Stage Input

- Reverse Polarity Stage Monitoring
- Stage 1: Apply Power to Stage 1 +ve & Stage 1 -ve
- Stage 2: Apply Power to Stage 1 +ve & Stage 1 -ve & connect Stage 2 -ve to Stage 1 -ve



Common +ve IN  
 Common +ve OUT

Stage 1 +ve  
 Stage 1 -ve

Stage 1 -ve OUT  
 Stage 1 -ve IN

Stage 2 -ve  
 Stage 2 +ve

Stage 2 -ve  
 Stage 3 -ve

Stage 2 -ve  
 Stage 2 +ve

Set H1 & H2 to -ve switching

Set H1 & H2 to -ve switching

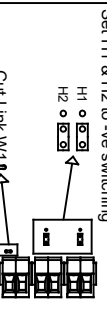
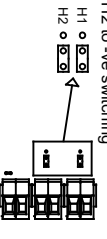

DRAWING TO BS8886:2000  
 GEOMETRIC TOLERANCES TO ISO1101:1983  
 UNLESS OTHERWISE SPECIFIED  
 ALL DIMENSIONS IN MILLIMETERS  
 UNLESS OTHERWISE SPECIFIED

DRAWN DATE 16/03/2021  
 R.S. RAIT

CHECKED DATE 16/03/2021  
 B.S. ISARD

APPROVED DATE 16/03/2021  
 R.N. POTTS

STANDARDS ALTERNATIVE MATERIAL

THIS DRAWING AND ANY INFORMATION OR DESCRIPTION MATTER HEREIN IS COMMUNICATED IN CONFIDENCE AND IS NOT TO BE DISCLOSED OR REPRODUCED IN ANY MANNER WITHOUT THE WRITTEN CONSENT OF THE MANUFACTURER OR FURNISHER OF THE GOODS. THE DATE OF ISSUE SHOWN ABOVE IS THE LATEST DATE OF ISSUE.

ALL DIMENSIONS IN MM  
 IF IN QUOTE 'ASK'  
 DO NOT SCALE

ALTERNATIVE MATERIAL WEIGHT (KG)  
 TITLE A112N & A121 DC SOUNDER  
 WIRING DIAGRAMS  
 SCALE SHEET 2 OF 3  
 DRAWING NUMBER D221-06-001

ALERT/LARM RANGE  
 APPROVED DATE 16/03/2021  
 R.N. POTTS

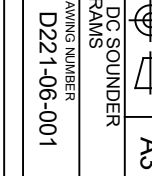
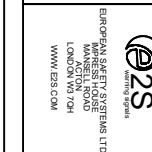

OPTIONAL LINE MONITORING RESISTOR, CUSTOMER SUPPLIED.  
 14V MAX SYSTEM = 120Ω MIN, 20V MIN OR 1KΩ MIN, 0.5W MIN.  
 28V MAX SYSTEM = 470Ω MIN, 20V MIN OR 2.4KΩ MIN, 0.5W MIN.



**Two Stage Configuration**

Line Stage Monitoring (Use suitable monitoring relays/modules)

Config.: 4 Two/Three Stage Voltage Free Activation Configuration  
 Customer Set H1 & H2 to Negative Switching (See Below)

Config.: 5

Not to be used for reverse polarity monitoring

- Stage 1: Apply Power to Stage 1 +ve & Stage 1 -ve
- Stage 2: Apply Power to Stage 2 +ve & Stage 2 -ve

- Power: +ve & -ve
- Stage 1: Connect Stage 1 -ve to Common -ve
- Stage 2: Connect Stage 2 -ve to Common -ve
- Stage 3: Connect both Stage 1 -ve & Stage 2 -ve to Common -ve



Stage 1 +ve

+



+

Stage 1 -ve

-



+

Stage 2 +ve

+



-

Stage 2 -ve

-

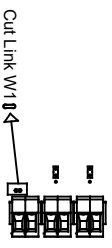

CUSTOM CONFIGURATION CONTACTS WHEN ORDERING



+ve IN

+ve OUT

-ve IN/COMMON

Stage 1 -ve

Stage 2 -ve

Stage 1 -ve

Stage 2 -ve

+

+

-

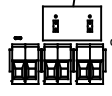

CUSTOM CONFIGURATION CONTACTS WHEN ORDERING

Set H1 & H2 to -ve switching

DRAWING TO OS9888-2000  
 GENERAL DIMENSIONS TO ISO 1101:1983  
 ANGULAR DIMENSIONAL TOLS

DRAWN R.S.RAIT

DATE 16/03/2021

SURFACE FINISH

WEIGHT (KG)

MATERIAL



ALL DIMENSIONS IN MM  
 IF IN QUOTE /ASK -  
 DO NOT SCALE



A3

STANDARDS

ALERT/ALARM RANGE

CHECKED B.ISARD

DATE 16/03/2021

APPROVED R.N.POTTS

ALTERNATIVE MATERIAL

EUROPEAN SAFETY SYSTEMS LTD  
 MANSELL ROAD  
 LONDON W10 4QH  
 WWW.E2S.COM

TITLE A112N & A121 DC SOUNDER  
 WIRING DIAGRAMS

SCALE SHEET 3 OF 3

DRAWING NUMBER D221-06-001



Single Stage Configuration Stage 1: Apply Power to Stage 1 Live & Stage 1 Neutral	Config.: 1a	Three/Four Stage Configuration Stage 1: Apply Power to Live & Neutral Stage 2: Apply Power to Live & Neutral & connect Stage 2 to Common Stage 3: Apply Power to Live & Neutral & connect Stage 3 to Common Stage 4: Apply Power to Live & Neutral & connect both Stage 2 & Stage 3 to Common	Config.: 1b	Two Stage Voltage Free Activation Configuration Power: Live & Neutral Stage 1: Connect Stage 1 to Common Stage 2: Connect Stage 2 to Common Stage 3: Connect both Stage 1 & Stage 2 to Common	Config.: 2
--	-------------	---	-------------	---	------------

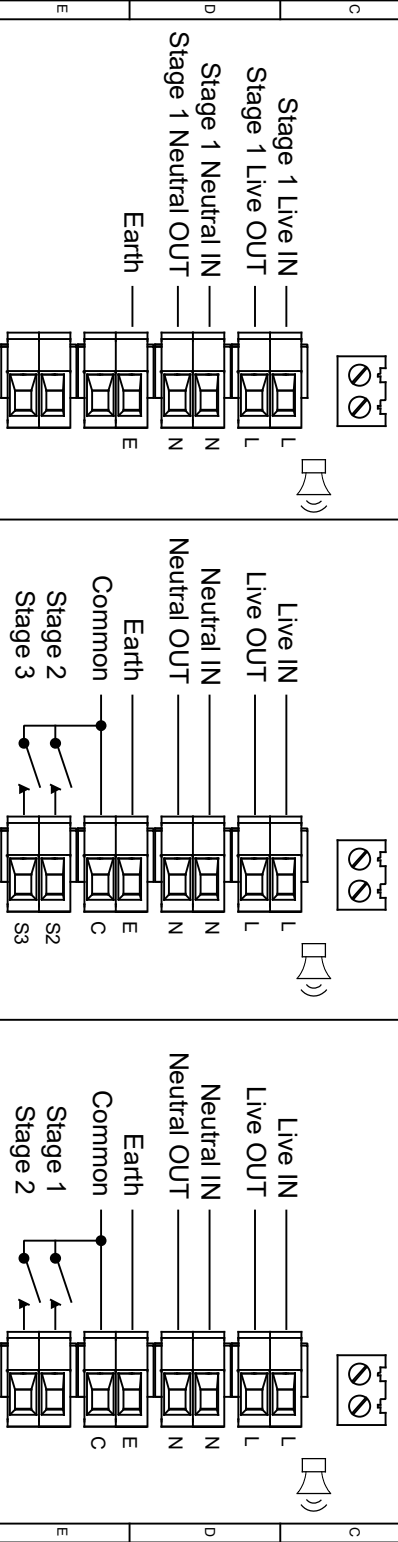

**CUSTOM CONFIGURATION CONTACT EZS WHEN ORDERING**

DRAWING TO BE ENHANCED TO ISO 11:1983 GEOMETRIC TOLERANCES TO ISO 11:1983 ANGULAR DIMENSIONAL TOLS	DRAWN R. S. PAIT	DATE 16/03/2021	SURFACE FINISH	WEIGHT (KG)	<p>THIS DRAWING AND ANY INFORMATION OR DESCRIBING MATTER THEREIN IS COMMUNICATED IN CONFIDENCE AND IS NOT TO BE DISCLOSED OR REPRODUCED IN ANY MANNER WITHOUT THE WRITTEN CONSENT OF THE MANUFACTURER OR FURNISHER. IT IS FOR THE EXCLUSIVE USE OF THE CUSTOMER AND IS NOT TO BE REPRODUCED OR TRANSMITTED IN ANY MANNER WITHOUT THE WRITTEN CONSENT OF THE MANUFACTURER OR FURNISHER.</p> <p>© AS PER LATEST DATE OF ISSUE SHOWN ABOVE</p>	<p>ALL DIMENSIONS IN MM IF IN QUOTE 'ASK' DO NOT SCALE</p> <p>SCALE: 1 OF 1</p> <p>SHEET: DRAWING NUMBER D221-06-005</p>
STANDARDS ALERT/LARM RANGE	CHECKED R. S. PAIT	DATE 16/03/2021	MATERIAL	APPROVED R. N. POTTS	DATE 16/03/2021	ALTERNATIVE MATERIAL



Page left Intentionally blank